



ABH ENGINEERING AND CONTRACTORS
Technology crafted with precision

ABH ENGINEERING AND CONTRACTORS

COMPANY PROFILE

Company Overview

Founding Year	2011
Founders	N Vijayan & Abhilash V Nair
Industry	Engineering and Contractors
Employees	15+
Onsite Manpower	150+

Mission

Our mission is to provide reliable infrastructure solutions, prioritizing safety, sustainability, and customer satisfaction. To become a respected Company who manufactures quality cranes and provides equipment erection and piping services at the most competitive costs.

Vision

Our vision is to become a leader in Industrial Equipment supply and services business, be recognized for our commitment to Quality, sustainable and customer-centric solutions in all the segments.

Our Offerings



Overhead Cranes

Single/Double Girder EOT Cranes, Ladle Cranes, Process Cranes, Goliath Cranes, JIB Cranes .



Crane Spare Parts

Hoist Spare Parts, All individual machineries of the crane, Individual Mechanical Assemblies (End-carriages, Crab Assembly etc.)



Services Offered

Heavy Structural Fabrication and Erection, Heavy Equipment Erection and Alignment, Industrial Piping Works, Crane Modification, Erection and Maintenance,

Why Choose Us

- ✓ Trusted reputation for consistent on-time product deliveries and ensuring unparalleled quality
- ✓ Implementing streamlined supply chain and provide maximum efficiency with Comprehensive Solutions
- ✓ Upholding Industry Expertise with industry-leading standards and Quality Assurance.
- ✓ Providing Customer-Centric service with responsive 24/7 support, and partnering for mutual success

What Our Customer Say

ABH Engineering & Contractors consistently deliver high-quality products on time. Their professionalism and customer-centric approach set them apart. I highly recommend them for reliable manufacturing and contracting services.

– Mr. S. Suri
Chairman – PSPPL



ABH ENGINEERING AND CONTRACTORS
Technology crafted with precision

ABH ENGINEERING AND CONTRACTORS

COMPANY PROFILE

EXECUTIVE SUMMARY

ABH Engineering & Contractors (ABH E&C), is an 14-year-old EOT Crane(s) manufacturing Firm, under the leadership of Mr Abhilash Nair, Currently ABH E&C is into Manufacturing, Modification and servicing of Overhead Cranes along with Supply of Spares part for Overhead Cranes. We also undertake Industrial Equipment Erection and Alignment works, Piping works and Insulation works. Over past years ABH E&C has worked with marquee customer such as **JSW, JSPL, Uttam Steel, Epsilon** to name a few, and has achieved significant growth in turnover over the years.

COMPANY PROFILE

Established in 2011, ABH Engineering & Contractors has emerged as a prominent player in the manufacturing, supply, and service provision sectors. Our diverse offerings include overhead cranes, shed structures, crane modification services, spare parts, EOT crane fabrication, crane erection services, equipment erection and alignment, piping, and insulation services. We prioritize superior quality, utilizing the finest components and modern machinery, with stringent quality checks before shipment. Our services are highly valued for their effectiveness and superiority, available in standard and customized options at competitive rates and within promised timelines.

To ensure efficient operations, we have established a world-class infrastructure, divided into departments such as manufacturing, R&D, marketing and sales, and quality testing. Our skilled and dedicated personnel, meticulously selected for their expertise and experience, work collaboratively towards achieving our organizational goals. This cohesive effort has enabled us to build a broad customer base nationwide.

Mr. N. Vijayan's leadership has been instrumental in our success, characterized by a relentless pursuit of knowledge, extensive business acumen, and a keen understanding of evolving client needs. His visionary approach has propelled us to the forefront of the industry, solidifying our position as a leading business entity.



ABH ENGINEERING AND CONTRACTORS
Technology crafted with precision

ABH ENGINEERING AND CONTRACTORS

COMPANY PROFILE

Overhead Cranes



Single Girder EOT Cranes



Double Girder EOT Cranes



Ladle Cranes



Process Cranes
Magnet, Slab Handling, Scrap
Charging & Grab Buckets Cranes



Goliath Cranes



JIB Cranes

EOT Crane Spare Parts



End Carriage



Grab Assembly



Gearbox



Rope Drum



Crane Wheels



Bottom Block



Grab Bucket



Ladles



ABH ENGINEERING AND CONTRACTORS
Technology crafted with precision

ABH ENGINEERING AND CONTRACTORS

COMPANY PROFILE

Image Gallery

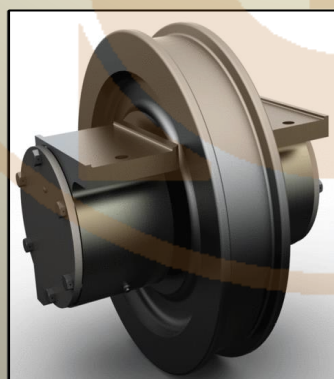
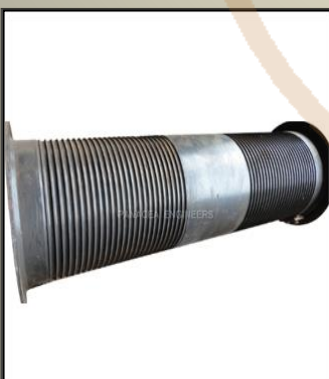
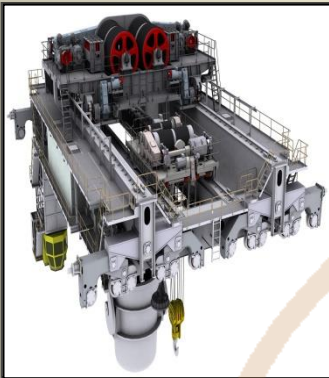



ABH ENGINEERINGS AND CONTRACTORS
Technology crafted with precision

ABH ENGINEERINGS AND CONTRACTORS

COMPANY PROFILE

Services Offered



HEAVY FABRICATION WORKS

Construction of metal structures & vessels according to design drawings.



EQUIPMENT ERECTION WORKS

Transporting equipment from storage, erecting it on foundations, levelling, aligning, and grouting.



INDUSTRIAL PIPING WORKS

Wide range of applications such as heating, cooling, filtration, steam generation, and compression.



OVERHEAD CRANE SERVICES

Complete Lifecycle care approach, ensuring that cranes are managed with the utmost attention.

Image Gallery

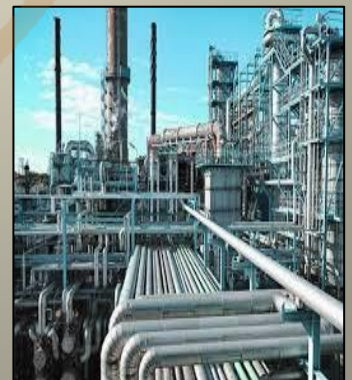
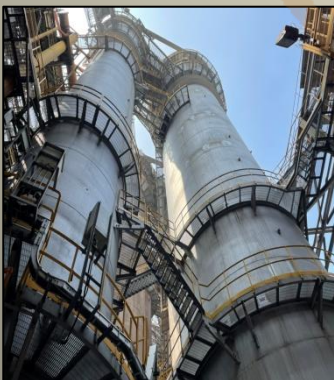
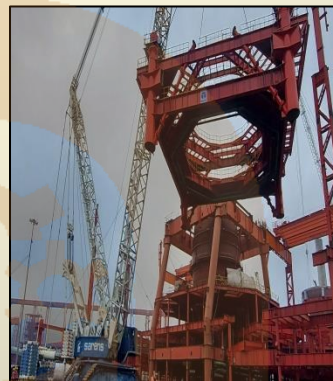



ABH ENGINEERING AND CONTRACTORS
Technology crafted with precision

ABH ENGINEERING AND CONTRACTORS

COMPANY PROFILE

Our Clients

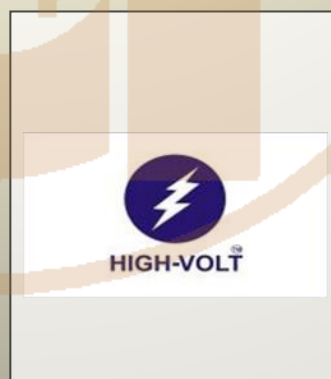
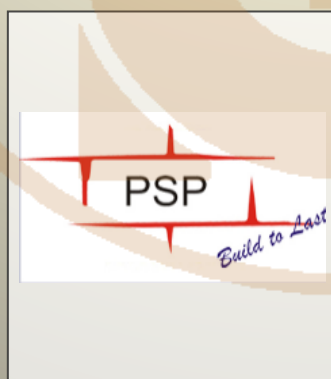



ABH ENGINEERINGS AND CONTRACTORS
Technology crafted with precision

ABH ENGINEERINGS AND CONTRACTORS

COMPANY PROFILE

Contact Us

Office Address

C-1/202, Anand Sagar Enclave, Opp Don Bosco School,
Next to Neelkanth Srishti, Wadeghar, Kalyan West,
Thane, MH – 421 301.

Email Address

- info@abhec.com
- multifab@live.in

Phone Numbers

- 9175466666 | 9004900466
- 9766466664 | 9324872084

